



ECOROOM



EN

Installation manual and commissioning



Contents

1. General information
2. Technical information
3. Installation
4. Characteristics and electrical connections
5. Commissioning the ECOROOM
6. Maintenance

The packaging contains:

1. ECOROOM x 1
2. Mural wall seal x 1
3. Halo x 1
4. Template x 1
5. Fixation kit x 1
6. Instructions x 1



1. GENERAL INFORMATION

1.1 - Introduction

This manual is destined for use with the ECOROOM.

Its aim is to provide the maximum information and safety during installation, set-up and use.

As our products are in constant development, Soler & Palau reserves the right to modify this manual without prior notification.

1.2 – Guarantee and civil liability

Guarantee

The ECOROOM heat recovery unit is guaranteed for two years from the date of purchase.

This guarantee includes free supply of spare parts.

This guarantee does not cover:

Assembly and disassembly expenses

Any breakdowns which according to Soler & Palau are due to poor installation, manipulation, negligence or accident.

Any breakdowns occurring after manipulation or repair by third parties without the authorisation of Soler & Palau.

To return a faulty part, the user should first contact the installer.

Civil liability

The ECOROOM has been designed for ventilation systems that enable the renewal of air in private homes. Soler & Palau will not be held liable for damage produced by:

- Misuse,
- Normal wear and tear of components,
- Non-observance of the instructions contained in this manual regarding safety, use and start-up,
- The use of components not supplied by Soler & Palau.

1.3 - Safety

General safety rules

After installation, there should be no risk with the security, health or environmental hazards, in compliance with EC regulations. This is also valid for the rest of the products used in the installation.

The following general instructions are important:

Follow the safety instructions to avoid any damage to the fans or harm to people.

The technical characteristics of this manual must not be modified.

The motor fans must not be modified.

The motor fans must be connected to a single-phase 230 VAC / 50 Hz electricity supply.

For the installation to be in compliance with EC regulations, the IDEO 325 Ecowatt heat recovery must be connected to the electricity supply in compliance with current regulations.

The unit must be installed in such a manner that, in normal operating conditions, there is no risk of contact with moving and/or live parts.

The IDEO 325 Ecowatt complies with regulations on electrical units.

Before any intervention on the unit, always disconnect it from the electrical power supply.

Always use the right tools.

Only use the unit for the purpose it was designed for.



2. TECHNICAL INFORMATION

2.1 – General information

The ECOROOM provides optimum ventilation for a room with a maximum energy recover. It extracts air from room and supply fresh air. The fresh air end extracted flow are separated and filtered. Only the energy from the extracted air is transferred to the new fresh air introduced. Exchanger with high efficiency of ECOROOM efficiency can reach 75%.

2.2 - Description

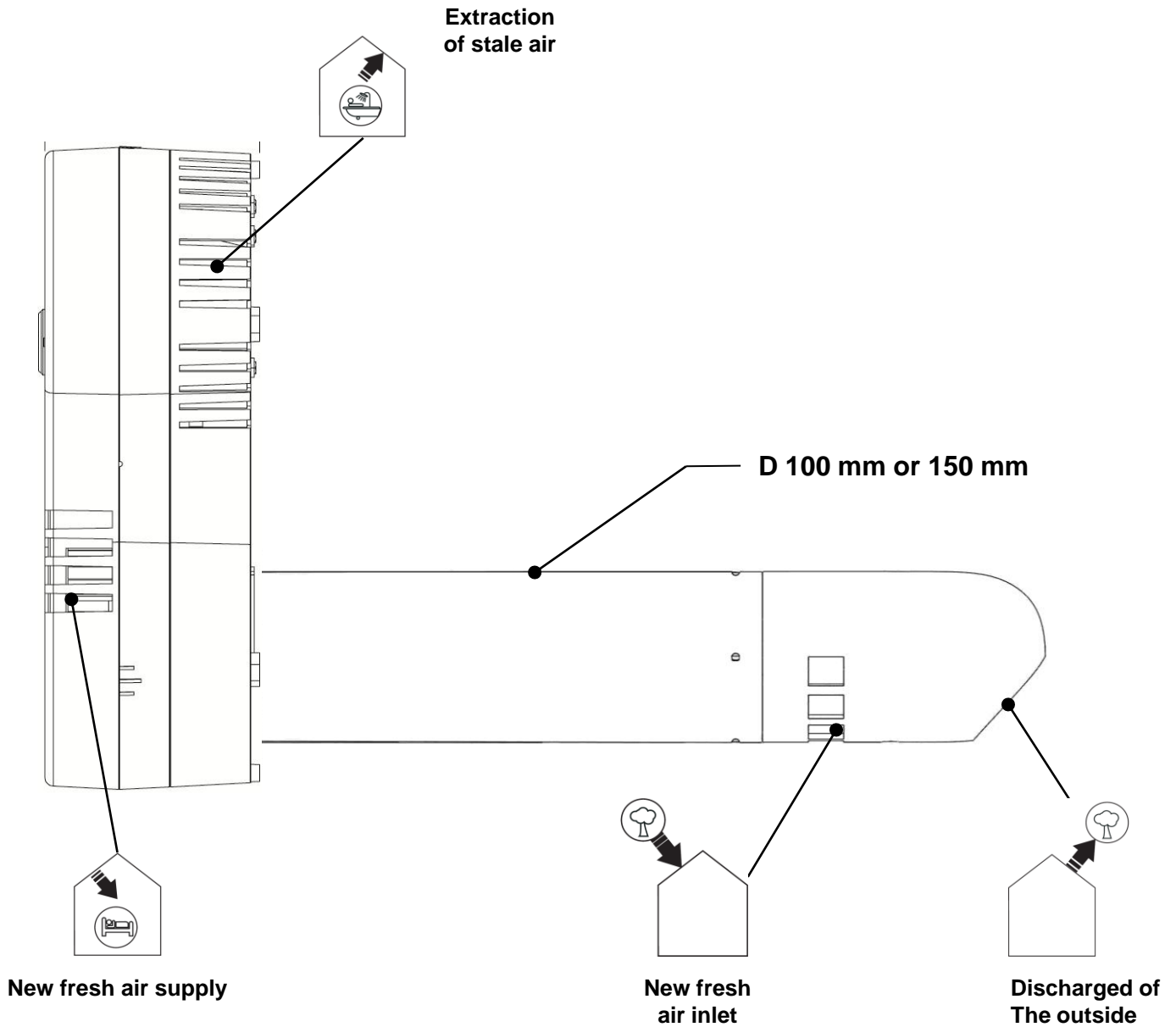

2.3 – Characteristics:

- Exploded view

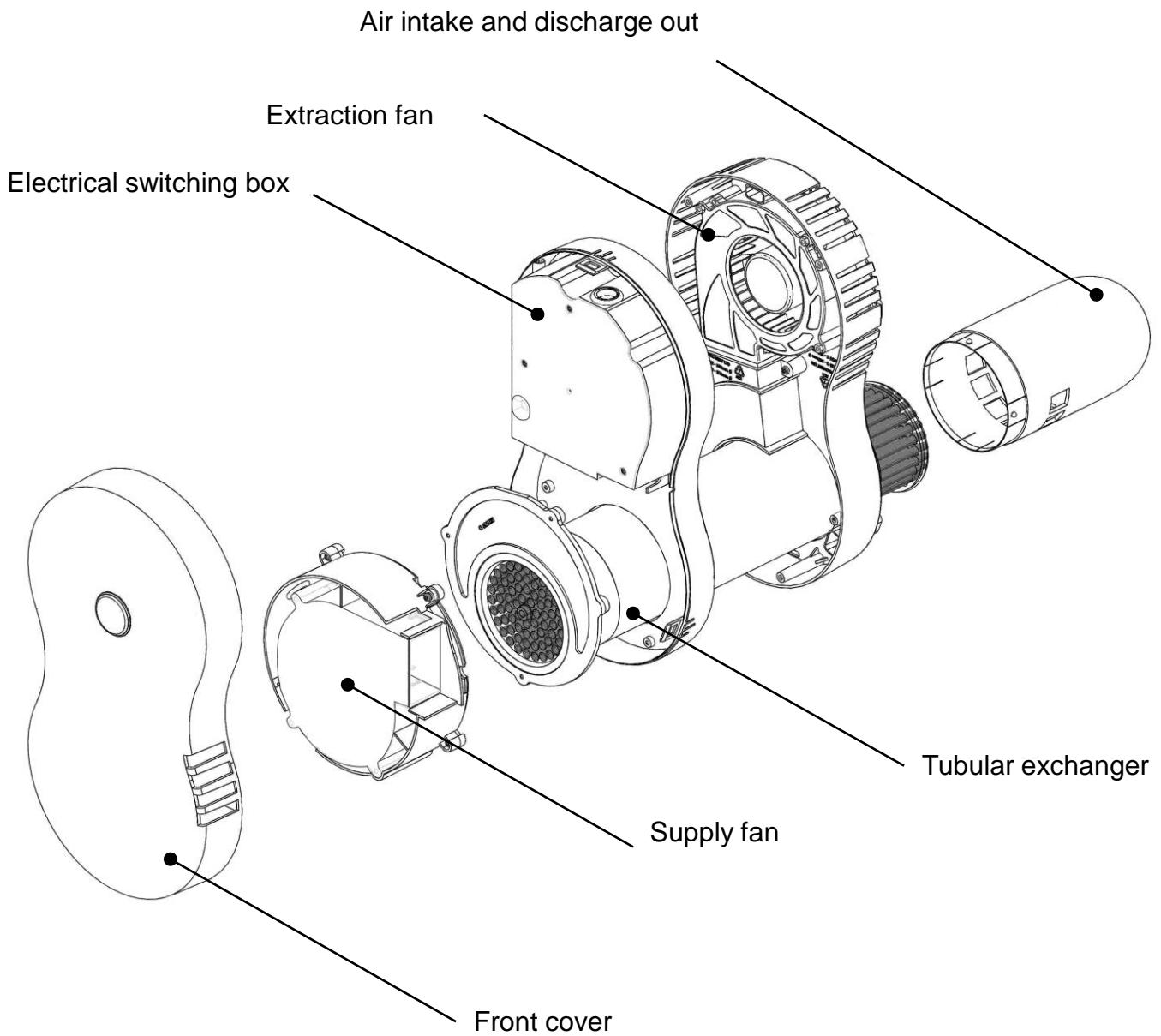

Weight: 3 Kg (D100mm)
3,2Kg (D150mm)

- Dimensions

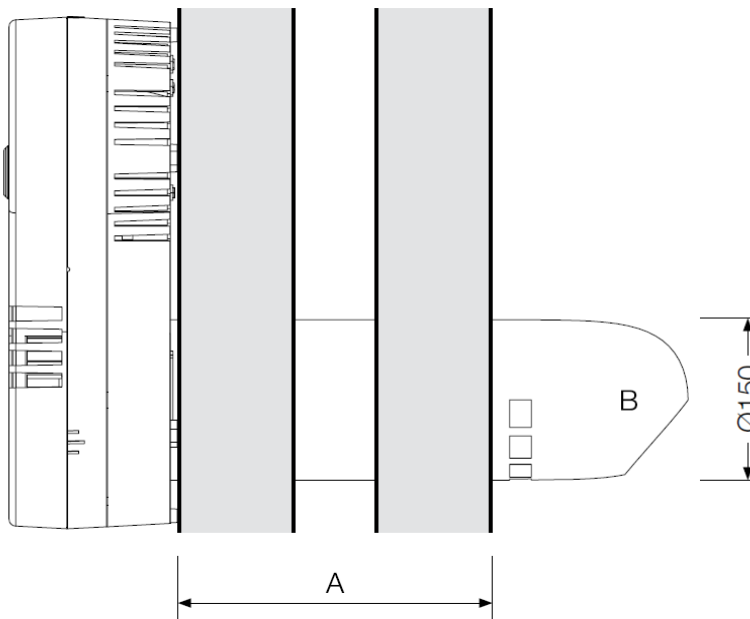
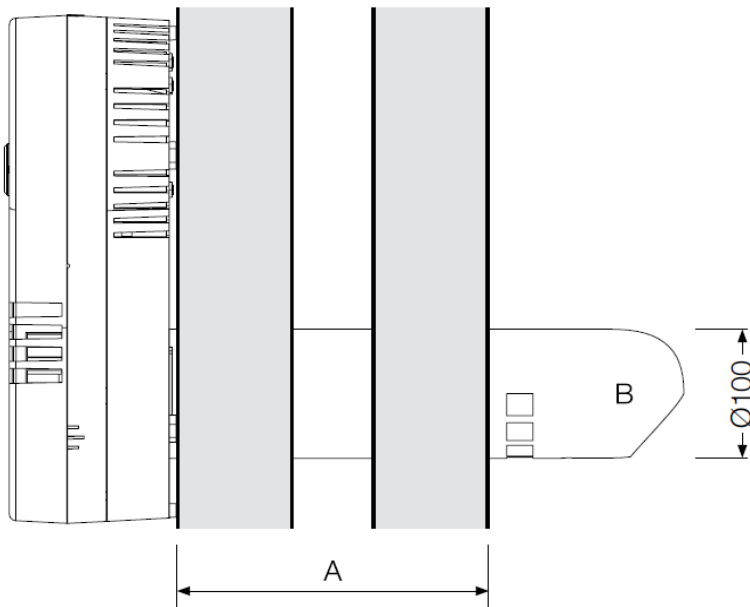
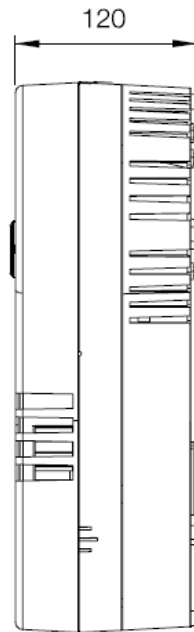
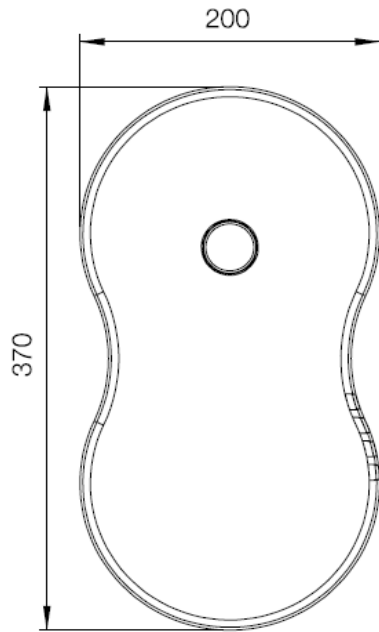

Wall thickness in mm (A)	Exchanger model (B)
100-310	310
311-430	430
431-500	500
501-600	600

3. INSTALLATION

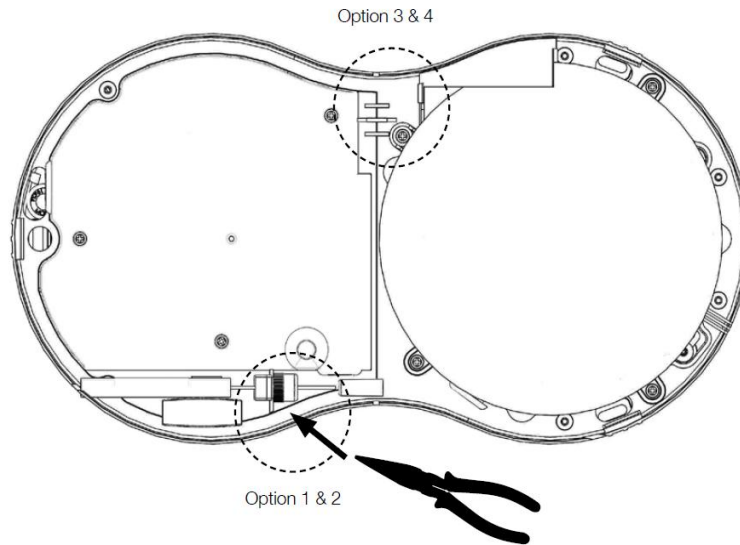
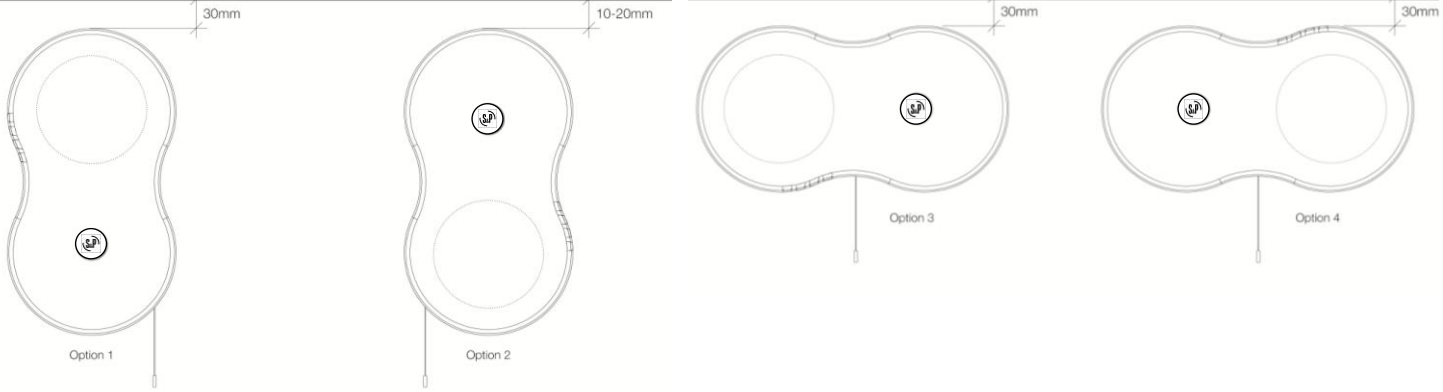

-1-

Choose the mounting direction in relation to the ceiling, Maintaining a minimum distance.

Adjust the fixation of the cord in accordance with the mounting direction.

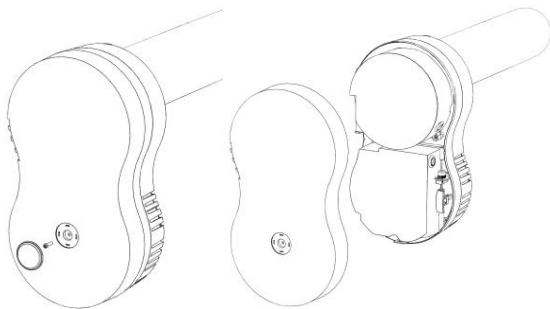

-2-

Remove the cover

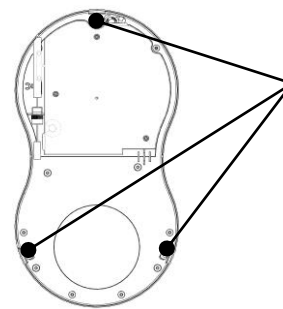

-3-

Use the 3 mounting holes

Mounting holes

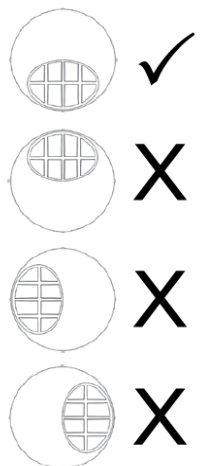

Mounting with wall seal:

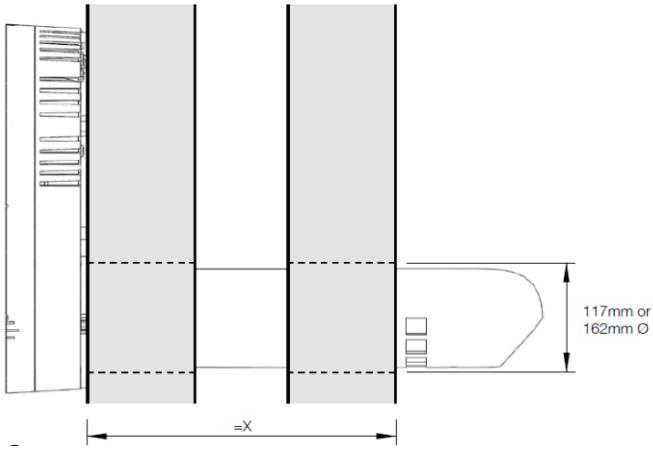

-4-a

Drill the hole of 117 mm or 162 mm

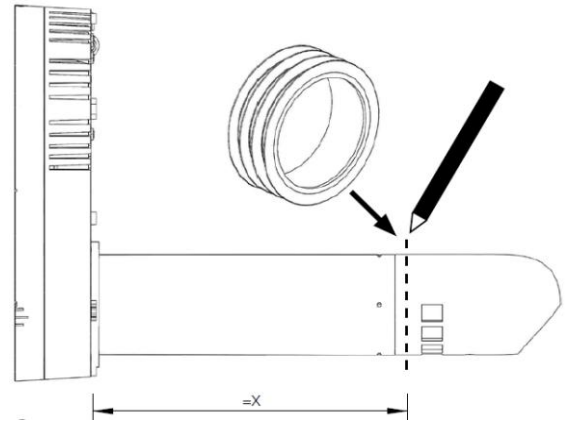

-5-a

Mark the position of wall seal. X= Wall thickness

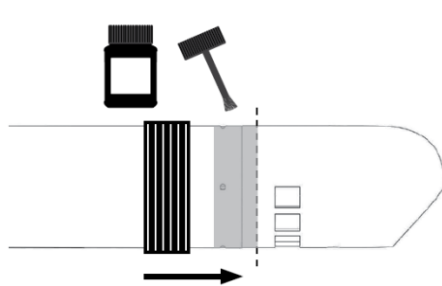

-6-a

Glue the wall seal and remove any superplus glue.

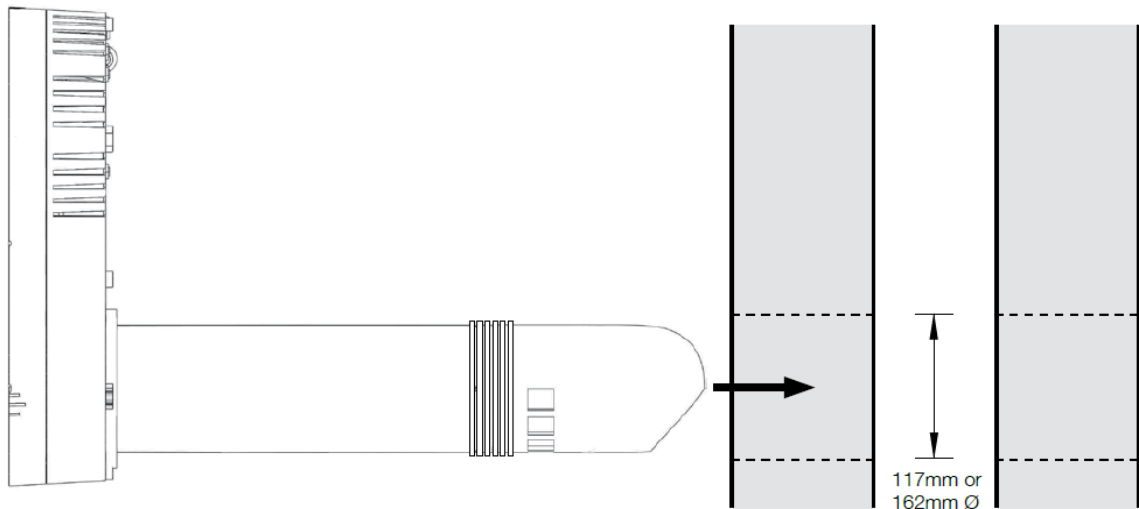
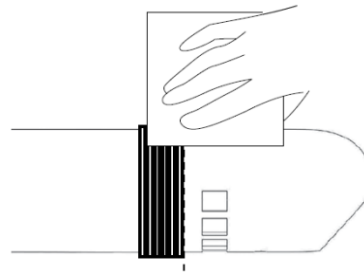

-7-a

Mount the exchanger at the junction of the wall and secure the body using the 3 screws.

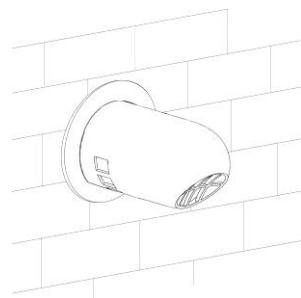
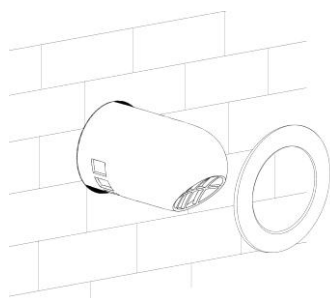

-8-

Position the halo on the exterior wall.

Mounting with sleeve (non delivered):

A	99 or 149 mm
B	Inside diameter of 100 or 150 mm as a minimum
C	Diameter 107 or 158 mm as a minimum
X	Wall thickness

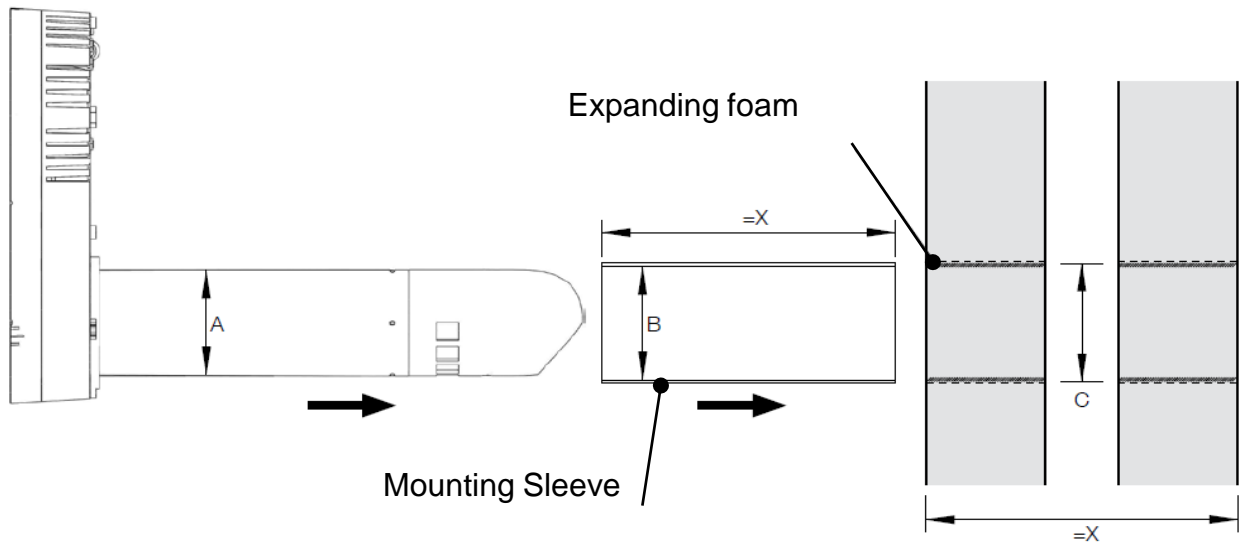

-4-b

Cut the mounting sleeve of inner diameter (B) to the length of the wall passage (X). Seal the mounting sleeve using the expanding foam. Mount the exchanger in the mounting sleeve and secure the body using the 3 screws.



-5-

Put the Halo in the outside wall

4. CONNECTIONS AND ELECTRICAL CHARACTERISTICS

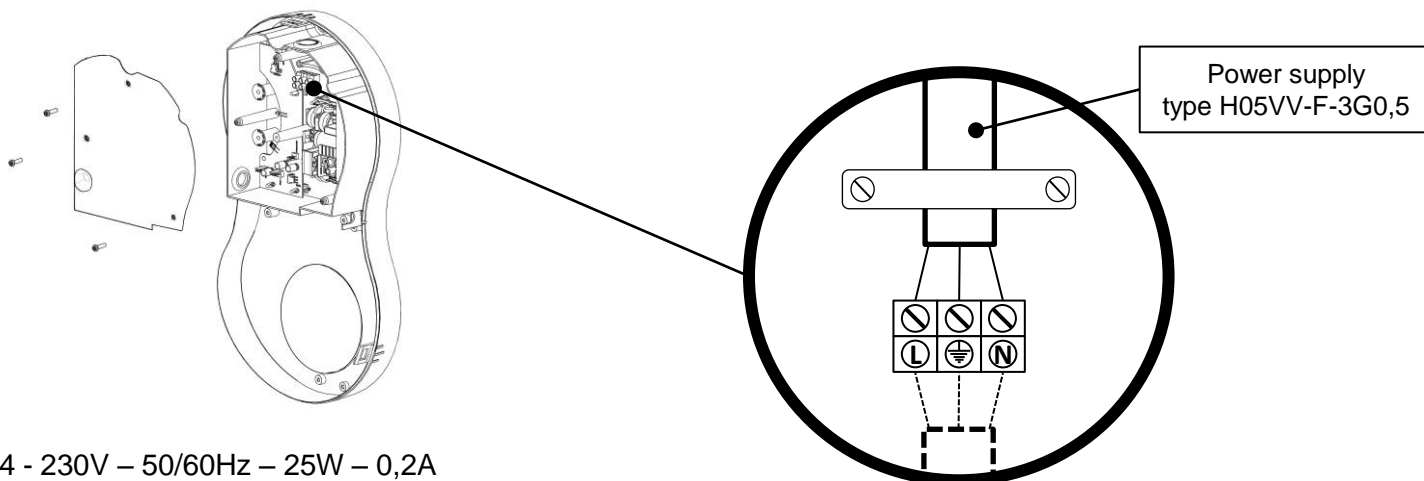

IPX4 - 230V – 50/60Hz – 25W – 0,2A
INDOOR USE.



5. CONTROL OF ECOROOM

- **Manually**

The EcoRoom has a cord which allows you to manually place it into « Boost » mode or to return to « Normal » mode simply by pulling the cord.

- **Hygrostat (automatic)**

The EcoRoom has an automatic humidity control system. If the humidity in the room in which is installed exceeds 65%, the EcoRoom increases its throughput accordingly. If the humidity drops, the airflow is reduced proportionately.

- **Summer bypass (automatic)**

The EcoRoom has a system that allows you to refrain from heating the room. This By-pass system cuts off the fresh air if the supply temperature is above 25°C.

- **Frost protection (automatic)**

The EcoRoom is equipped with a system which prevents the exchanger from freezing up when temperatures are extremely low. This prevents damage to the exchanger.

- **Comfort mode (automatic)**

The EcoRoom has a system which allows you to refrain from cooling down the room with fresh air. This system reduces the airflow of fresh air when the supply temperature is below 10°C.



6. MAINTENANCE

Review manually and clean if it is necessary all the components (fans, exchanger..)



Before carrying out any cleaning work on the system, make sure that it is disconnected from the mains.

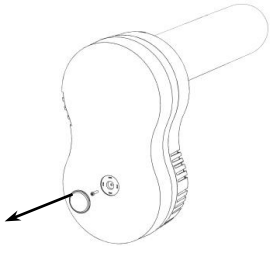

-1-
Open the cover.

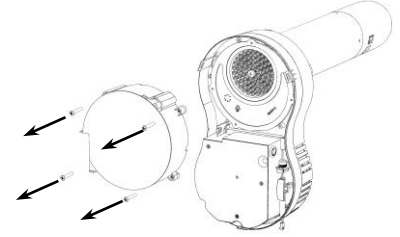
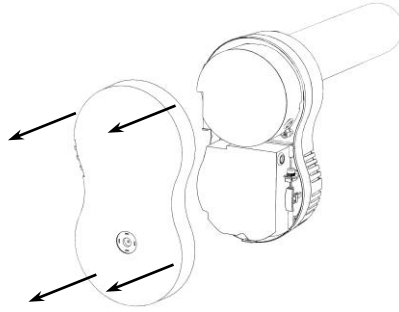

-2-
Dismantle the supply fan.

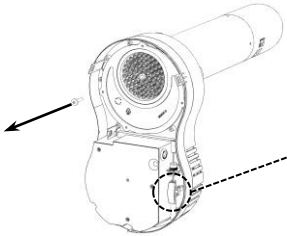

-3-
Loose the central screw.

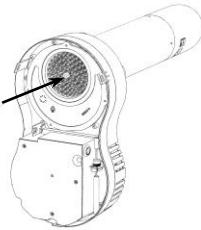

-4-
Turn the handle at the side of the Electrical box.

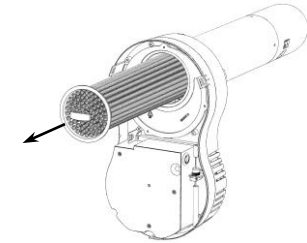
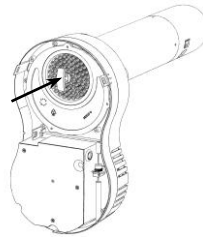

-5-
Extract the exchanger.



○



○



30

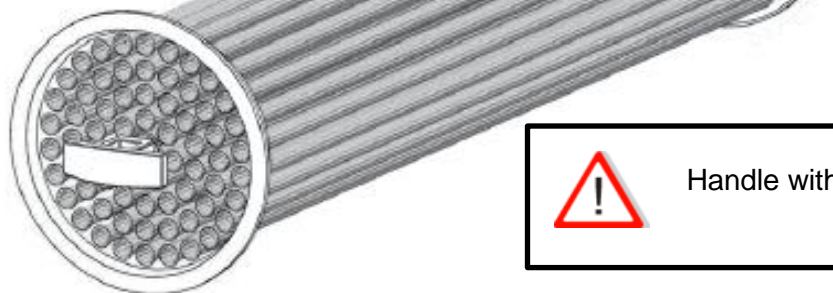

Handle with care



S&P SISTEMAS DE VENTILACIÓN S.L.U.

C/ Llevant, 4
08150 Parets del Vallès (Barcelona)
Tel. +34 93 571 93 00
Fax +34 93 571 93 01
www.solerpalau.com

Soler&Palau 
Ventilation Group

